

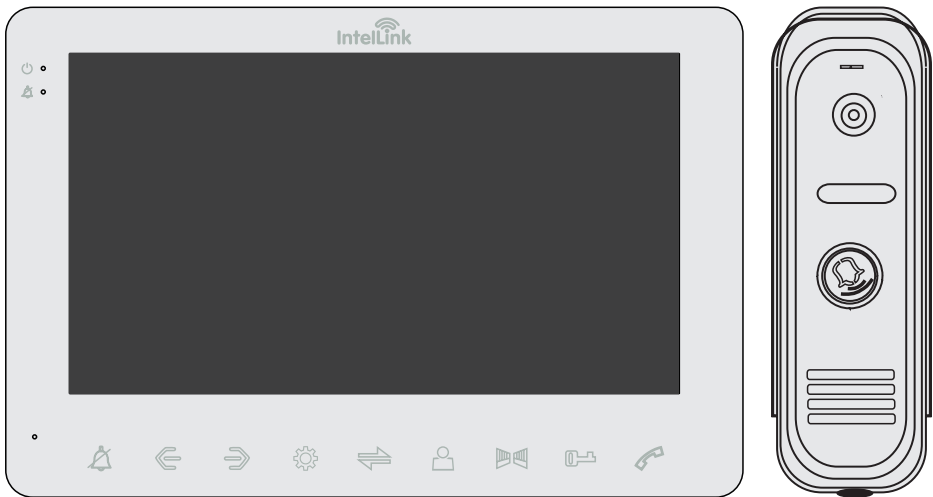

Video Intercom

QUICK SETUP GUIDE



model. **INT27WSK**



FIRE
SECURITY
INTERCOMS

TABLE OF CONTENTS

KIT CONTENTS	2
INSTALLATION	5
INTELLINK WIFI INTERCOM MOBILE APP - SETUP GUIDE	6
A. Introduction	6
B. Preparing the IntelLink Intercom for Connection	7
C. Pairing Intercom to IntelLink App (Steps for AP-mode connection)	8
WARRANTY & LIABILITY	11

KIT CONTENTS

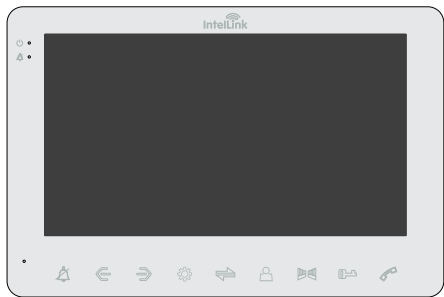

monitor



door station

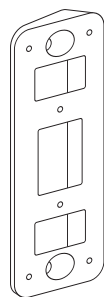

angle bracket

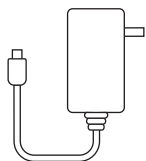

powersupply



connector leads, screws & plugs



Keep intercom wires more than 30cm away from AC mains power to avoid interference. The electric latch is not included in the package. Use 12VDC electric latch only. Do not exceed 500mA.

For stable connection to the IntelLink app, internet data connection is required at both intercom and mobile device.



The video monitor should be located within close range of modem with a strong Wi-Fi connection with at least 1.5Mbps upload connection speed.

If you are unsure of your Wi-Fi connection and speed, we suggest downloading a free Wi-Fi test app such as "Speedtest by Ookla" and test the connection at the intended location of the monitor.

If the Wi-Fi signal is low, we suggest moving your modem closer to the monitor or purchasing Wi-Fi extenders to boost your signal.

DEFAULTING TO FACTORY SETTINGS

To default the system to factory default settings, when monitor is in standby mode, press and hold  for 10 seconds.

The system will reboot and note all settings set by user will be erased and return to factory settings.

Cable Requirements

- CAT5e or CAT6***

Panacom	RED	BLACK	WHITE	YELLOW
CAT5e or CAT6***	BRN, BLU	BRN/WHT, BLU/WHT GRN/WHT, ORG/WHT	GRN	ORG

*** Cable distance ≤ 50 meters

*** For distances greater than 50m, refer to installation manual available online at www.intellink.com.au

WIRING DIAGRAM

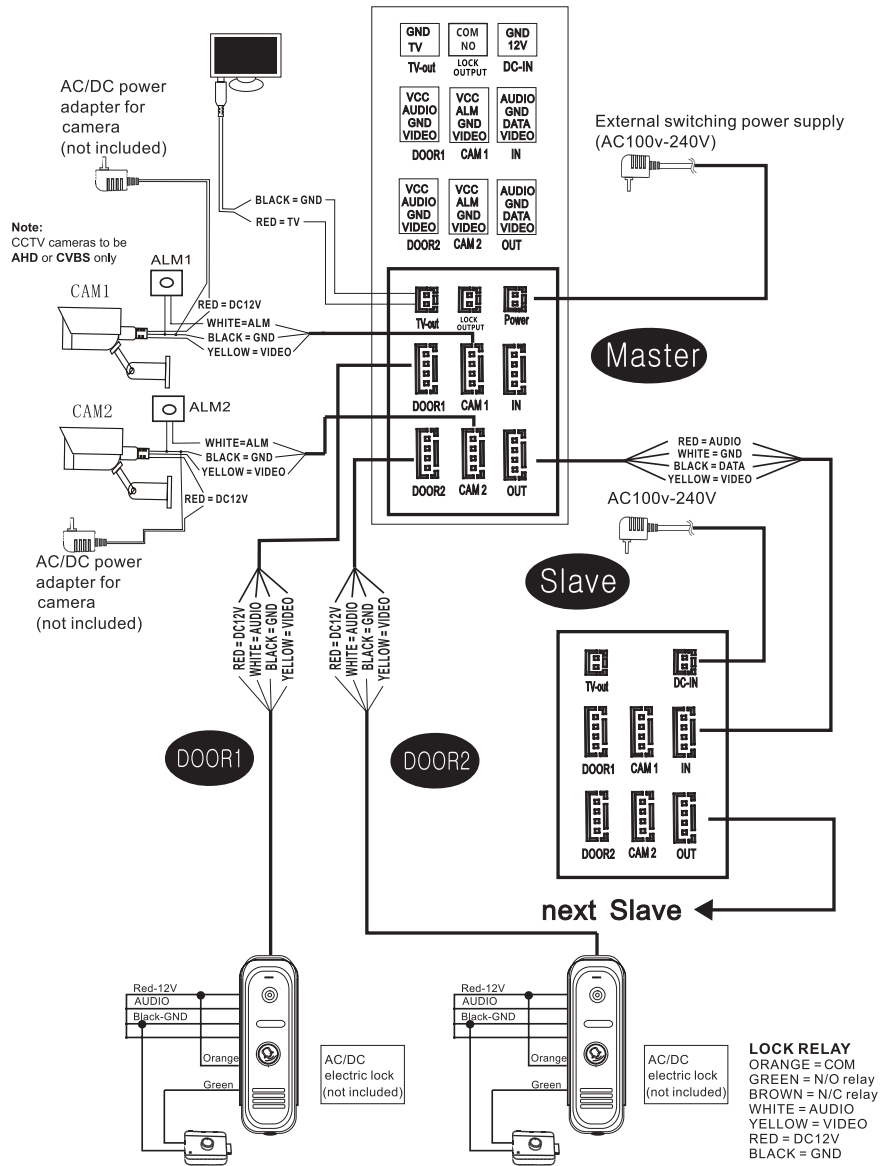

INSTALLATION

Monitor

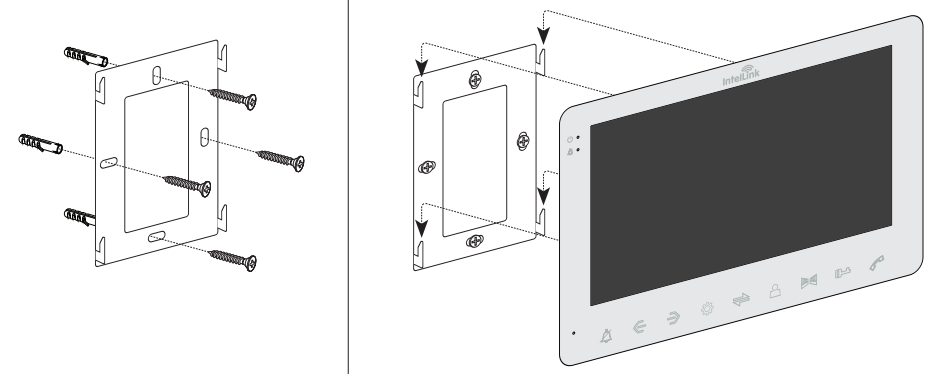

Door Station

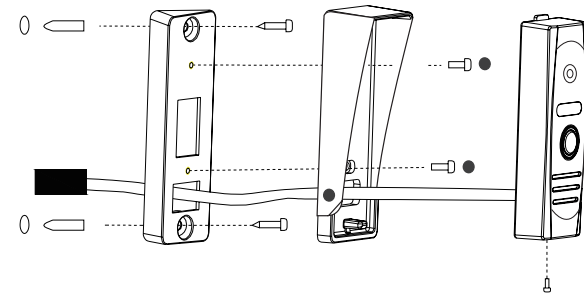

The first monitor is the MASTER monitor and ID must be set as Device 01. All other monitors are SLAVES and must be set as Device 02 to 06. To program the device ID go to MODE section.

INTELLINK WIFI INTERCOM

MOBILE APP- SETUP GUIDE

A. Introduction

This Setup Guide shows you how to configure the IntelliLink WiFi Intercom to connect with the Mobile App.







Getting the IntelliLink App

1. Download the free "IntelliLink" App from the Apple App Store, or the Google Play Store.
2. Tap the IntelliLink app icon to start the mobile app.
3. Register a free account with your Email account.

Note: The mobile App requires access to the Internet via 3G/4G or Wireless network.



B. Preparing the IntelliLink Intercom for Connection

1. Power up the IntelliLink Intercom
2. Press  to enter the Main Menu
3. Press  again to select the "System" icon.
4. In the System menu, press  &  to highlight the "Network Setting" icon. Then press  to confirm selection.
5. Press  again to choose the "Wi-Fi Set" icon.
6. In the next submenu, the 'AP-Mode' is already selected by default. Press  twice to confirm this default selection. The Monitor will reboot itself to enter AP-mode, and start a temporary hotspot ("Smartlife-xxxxxx")

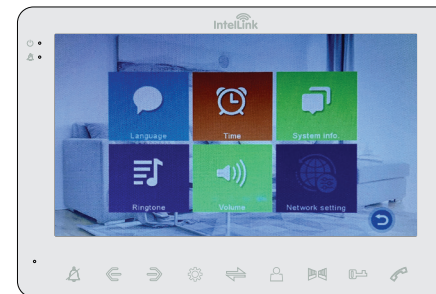

C. Pairing Intercom to IntelliLink App (Steps for AP-mode connection)

We are now ready to connect Intercom to IntelliLink App.

1. With your mobile phone, temporarily turn Airplane Mode to ON (with Mobile Data to OFF). Then re-enable the Wi-Fi function only on your phone.
2. In the IntelliLink App, tap "Add Device". Or tap the "+" icon on top right corner. (See Fig 1)
3. In the left column, tap "Intercom". Tap the "IntelliLink WiFi Intercom" icon. (See Fig 2)
4. Enter the login details of your local WiFi network, together with its password. Then tap "Next". (See Fig 3)

Important: Use your 2.4GHz WiFi settings, not the 5GHz band.

4. Confirm "AP Mode" is shown on top right corner of App screen. Tap the small circle to left of "Confirmed IntelliLink Monitor has rebooted". Tap "Next" to continue. (See Fig 4).
5. When prompted, go to the iPhone Settings, and select the Intercom's hotspot ("SmartLife-xxxx") as your Wi-Fi connection. Once successful, a check mark appears against the SmartLife (Intercom) in the WiFi menu. (See Fig 5 & 6)

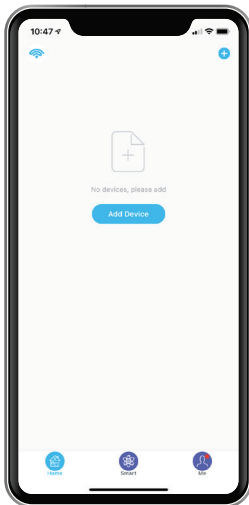

Figure 1.

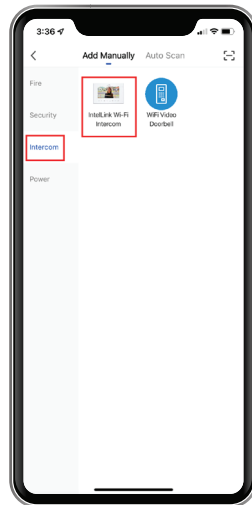

Figure 2.

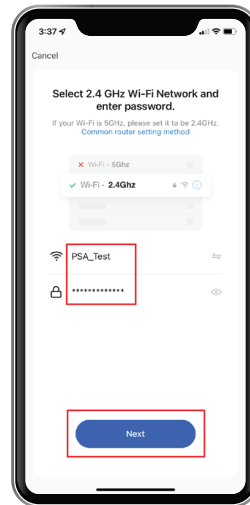

Figure 3.



Figure 4.

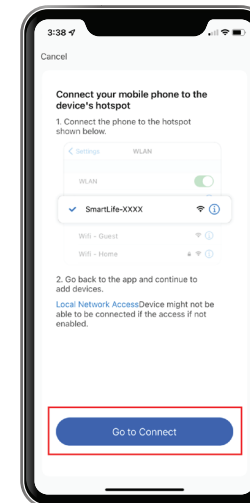

Figure 5.

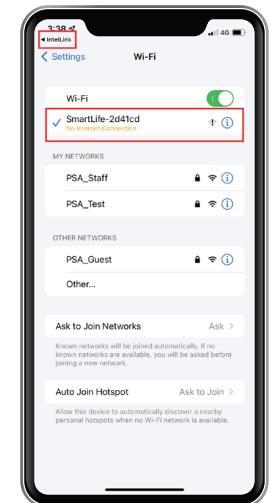

Figure 6.

- Switch back to the previous IntelLink App screen, and the App should automatically start connecting with the IntelLink Intercom (and register the device online). (See Fig 7)
- If successful, the App will report "Device added successfully". Tap "Done" to acknowledge. Congratulations, your phone is now paired with the IntelLink Intercom. (See Fig 8)
- Tap on the new 'IntelLink Wi-Fi Intercom' icon to test the connection. This should lead you to a control menu, which provides a Live View from the Door Station, plus other control options (e.g. to operate the door relay remotely). (See Fig 9)

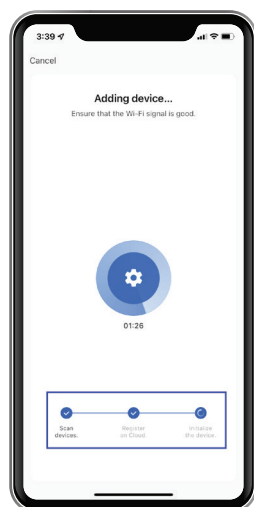

Figure 7.

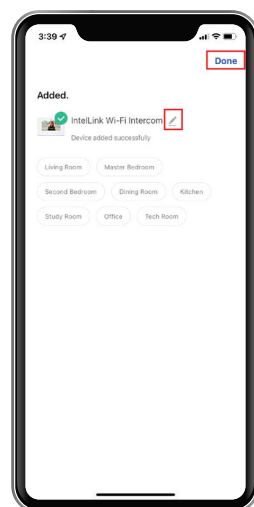

Figure 8.

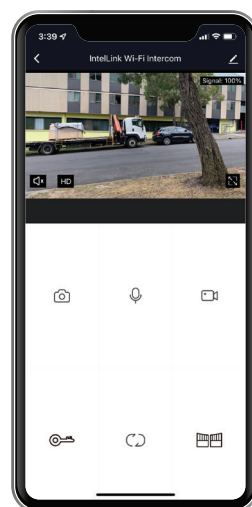

Figure 9.

WARRANTY & LIABILITY

- PSA Products Pty Ltd (ABN: 99 076 468 703) of 17 Millicent Street, Burwood 3125 Victoria, Australia warrants this product for a period of 24 months from the date of purchase, as reflected on the Authorised Resellers or Distributors invoice/ receipt provided to you. PSA Products Pty Ltd will repair or replace the product (at the option of PSA Products) due to any manufacturing defect, at the cost of PSA Products Pty Ltd (excluding any labour costs relating to removal or re-installation of product, and transport costs) .
- This warranty shall not apply to the product if it has been damaged, modified, abused or altered after the date of purchase, or if it fails to operate due to improper maintenance.
- To the extent permitted by law, the liability of PSA Products Pty Ltd arising from the sale or under the terms of this limited warranty shall not in any case exceed the cost of replacement and subject to this clause. In no case shall PSA Products Pty Ltd be liable for consequential loss or damages resulting from the failure of the product or breach of this, or: Any other warranty, express or implied, loss or damage caused by failure to abide by the instructions supplied in the leaflets.
- To the extent permitted by law, PSA Products Pty Ltd ., makes no warranty, expressed or implied, written or oral, including that of merchantability or fitness for any particular purpose, with respect to the consumer replaceable battery if any. A product with non-serviceable built-in battery is covered under warranty of the product as per point 1.
- This warranty is provided in addition to other rights and remedies you have under law: Our goods come with guarantees that cannot be excluded under the Australian Consumer Law. You are entitled to a replacement or refund for a major failure and compensation for any other reasonably foreseeable loss or damage. You are also entitled to have the goods repaired or replaced if the goods fail to be of acceptable quality and the failure does not amount to a major failure. What constitutes a major failure is set out in the Australian Consumer Law.
- To make a claim under warranty, take the product (with a proof of purchase) to the store where you purchased the product or contact PSA Products Pty Ltd . Phone (03) 9888 9889. or Email: enquiry@psaproducts.com.au with details, proof of purchase or expense claim in writing.



CONGRATULATIONS! You have now paired your IntelLink Video Intercom to the IntelLink App.

For the full user manual please visit www.intellink.com.au



17 Millicent Street, Burwood, VIC 3125 Australia

Tel: 1300 PSA PRODUCTS (1300 772 776)

Fax: (03) 9888 9993

enquiry@psaproducts.com.au

psaproducts.com.au